



Instruction Manual

Fun Pop 4 oz. Popper

Model Series: 2404, 2404MD



Model 2404MD



Model 2404



GOLD MEDAL® PRODUCTS CO.

10700 Medallion Drive, Cincinnati, Ohio 45241-4807 USA



Table of Contents

SAFETY PRECAUTIONS 3

INSTALLATION INSTRUCTIONS..... 5

 Inspection of Shipment5

 Manual.....5

 Model Description5

 Items Included with this Unit.....5

 Setup6

 Electrical Requirements7

 Before You Plug In Machine.....7

OPERATING INSTRUCTIONS..... 8

 Controls and Their Functions8

Popping Corn Instructions 9

Care and Cleaning 10

 Daily Kettle Cleaning Instructions10

 Daily Unit Cleaning Instructions.....11

Troubleshooting 12

AGITATOR SET COLLAR ADJUSTMENT..... 13

MAINTENANCE INSTRUCTIONS..... 14

ORDERING SPARE PARTS..... 15

 Replacing Broken Glass.....15

 4 oz. Kettle Assembly (54000) – Agitator Assembly View.....16

 4 oz. Kettle Assembly (54000) – Kettle Bottom Assembly17

 Cabinet Exterior – Front View18

 Cabinet Exterior – Rear View19

 Cabinet Interior – Hanger Assembly/Controls View20

 Cabinet Interior – Corn Pan/Element View21

 Dome Interior – Electrical Components22

 Safety Labels.....23

 Accessories.....23

Wiring Diagram..... 24

WARRANTY..... 25



SAFETY PRECAUTIONS

	⚠ DANGER
	<p>Machine must be properly grounded to prevent electrical shock to personnel. Failure to do so could result in serious injury, or death. DO NOT immerse any part of this equipment in water. DO NOT use excessive water when cleaning. Keep cord and plug off the ground and away from moisture. Always unplug the equipment before cleaning or servicing. Make sure all machine switches are in the OFF position before plugging the equipment into the receptacle.</p> <p>008_051514</p>

	⚠ DANGER
	<p>Improper installation, adjustment, alteration, service, or maintenance can cause property damage, injury, or death. Any alterations to this equipment will void the warranty and may cause a dangerous condition. This appliance is not intended to be operated by means of an external timer or separate remote-control system. NEVER make alterations to this equipment. Read the Installation, Operating, and Maintenance Instructions thoroughly before installing, servicing, or operating this equipment.</p> <p>014_020416</p>



	⚠ WARNING
	<p>To avoid burns, DO NOT touch the kettle or any heated surface. DO NOT place or leave objects in contact with heated surfaces.</p> <p>013_092414</p>



	⚠ WARNING
	<p>ALWAYS wear safety glasses when servicing this equipment.</p> <p>010_010914</p>

	⚠ WARNING
	<p>No user serviceable parts inside. Refer servicing to qualified service personnel.</p> <p>011_051514</p>

	⚠ WARNING
	<p>Read and understand operator's manual and all other safety instructions before using this equipment. To order copies of the operator's manual go to gmpopcorn.com or write to Gold Medal Products Co., 10700 Medallion Drive, Cincinnati, OH 45241 USA 1-(800)-543-0862</p> <p>022_060215</p>



	 WARNING
	DO NOT allow direct contact of this equipment by the public when used in food service locations. Only personnel trained and experienced in the equipment operation may operate this equipment. Carefully read all instructions before operation. 012_010914

	 WARNING
	This machine is NOT to be operated by minors. 007_010914

Note: Improvements are always being made to Gold Medal’s equipment. This information may not be the latest available for your purposes. It is critical that you call Gold Medal’s Technical Service Department at 1-800-543-0862 for any questions about your machine operations, replacement parts, or any service questions. (Gold Medal Products Co. does not assume any liability for injury due to careless handling and/or reckless operation of this equipment.) General images may be used in manual for reference only.



INSTALLATION INSTRUCTIONS

Inspection of Shipment

After unpacking, check thoroughly for any damage which may have occurred in transit. Claims should be filed immediately with the transportation company. The warranty does not cover damage that occurs in transit, or damage caused by abuse, or consequential damage due to the operation of this machine, since it is beyond our control (reference warranty in back of manual).

Manual

Read and understand the operator's manual and all other safety instructions before using this equipment. To order copies of the operator's manual go to gmpopcorn.com or write to Gold Medal Products Co., 10700 Medallion Drive, Cincinnati, OH 45241 USA 1-(800)-543-0862.

Model Description

2404: Fun Pop 4 oz. Popper with red and gold cabinet.

2404MD: Midnight 4 oz. Popper with black and silver cabinet.

Items Included with this Unit

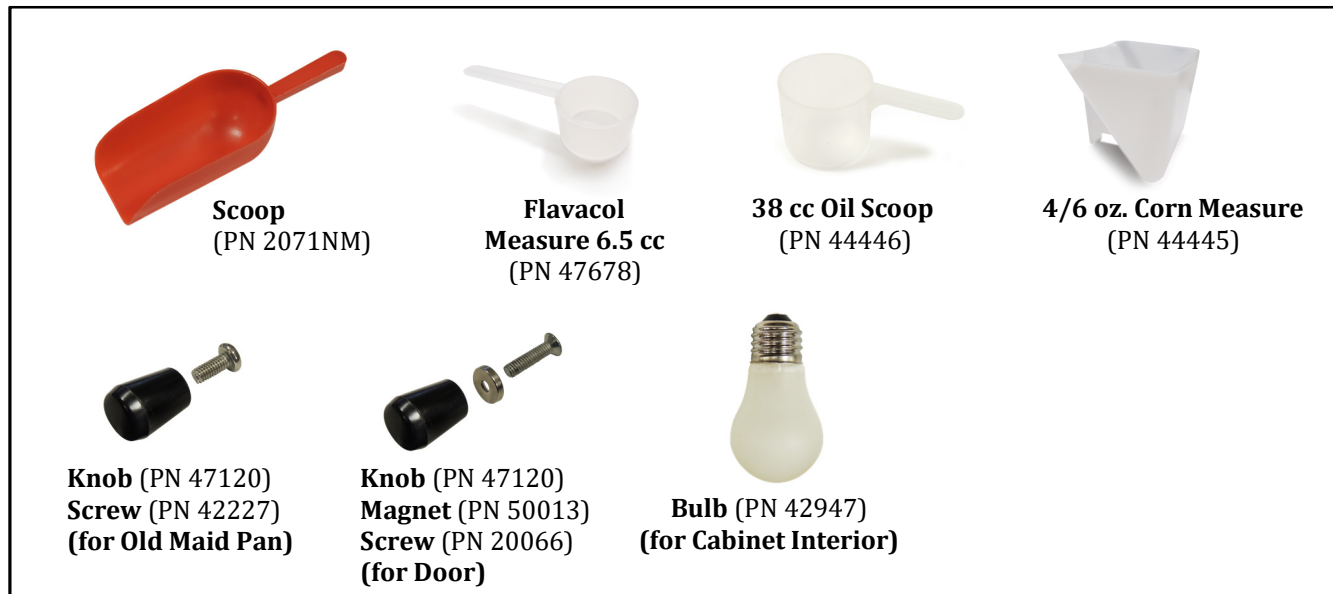



Setup

This unit has been tested at the factory.



1. Remove all packaging and tape prior to operation. Remove accessories and carefully remove kettle packed in cabinet interior.
2. Place the unit on a sturdy, level base.
3. Tilt kettle and insert into hanger arms, then allow kettle to return naturally to an upright position (see image below).
4. Plug kettle lead into receptacle located on ceiling of cabinet interior. Align keyed or hook shaped prong with the correct opening, then push plug all the way in and twist or rotate to lock in place. To unplug, untwist kettle plug before attempting to pull from receptacle.
5. Door knobs are shipped in accessories pack located inside machine. Install a door knob with magnet on popper door; install knob with screw on the old maid pan.
6. Carefully install the light bulb (do not over-tighten) into the lamp holder located in the cabinet interior. Ensure the unit is OFF and unplugged before installing or changing the bulb (reference the Electrical Requirements section).
7. After setup, unit should be cleaned prior to use (see Care and Cleaning section).



Electrical Requirements

The following power supply must be provided (reference unit Data Plate):

120 V~, 60 Hz

	 DANGER
	<p>Machine must be properly grounded to prevent electrical shock to personnel. Failure to do so could result in serious injury, or death. DO NOT immerse any part of this equipment in water. DO NOT use excessive water when cleaning. Keep cord and plug off the ground and away from moisture. Always unplug the equipment before cleaning or servicing. Make sure all machine switches are in the OFF position before plugging the equipment into the receptacle.</p> <p style="text-align: right; font-size: small;">008_051514</p>

A certified electrician must furnish sufficient power for proper machine operation and install any supplied receptacle. We recommend this equipment be on a dedicated and protected circuit. Failure to wire properly will void the warranty and may result in damage to the machine. It is Gold Medal Products Co.'s recommendation that this machine be plugged directly into a wall outlet. The use of extension cords is not recommended due to safety concerns, and may cause sacrificed and/or reduced performance. Make sure cord is located to prevent a trip hazard or unit upset.

Before You Plug In Machine

1. Make sure all machine switches are OFF before plugging equipment into receptacle.
2. Make sure wall outlet can accept the grounded plugs (where applicable) on the power supply cord.
3. The wall outlet must have the proper polarity. If in doubt, have a competent electrician inspect the outlet and correct if necessary.
4. **DO NOT** use a grounded to un-grounded receptacle adapter (where applicable).
5. Install unit in a level position.

	 CAUTION
	<p>If the supply cord is damaged, it must be replaced by Gold Medal Products Co., its service agent or similarly qualified persons in order to avoid a hazard.</p> <p style="text-align: right; font-size: small;">039_080614</p>



OPERATING INSTRUCTIONS

Controls and Their Functions

KETTLE HEAT SWITCH

Two position, ON/OFF lighted rocker switch - supplies power to the heating elements in the popping kettle. The green switch light ON indicates there is power to the kettle heating element.

KETTLE MOTOR SWITCH

Two position, ON/OFF lighted rocker switch - supplies power to the kettle agitator motor. The Kettle Motor Switch **MUST** be ON at all times when there is popcorn (popped or un-popped) in the kettle.

LIGHTS/WARMER SWITCH

Two position, ON/OFF lighted rocker switch - supplies power to the interior cabinet light, and heat element for the corn pan.

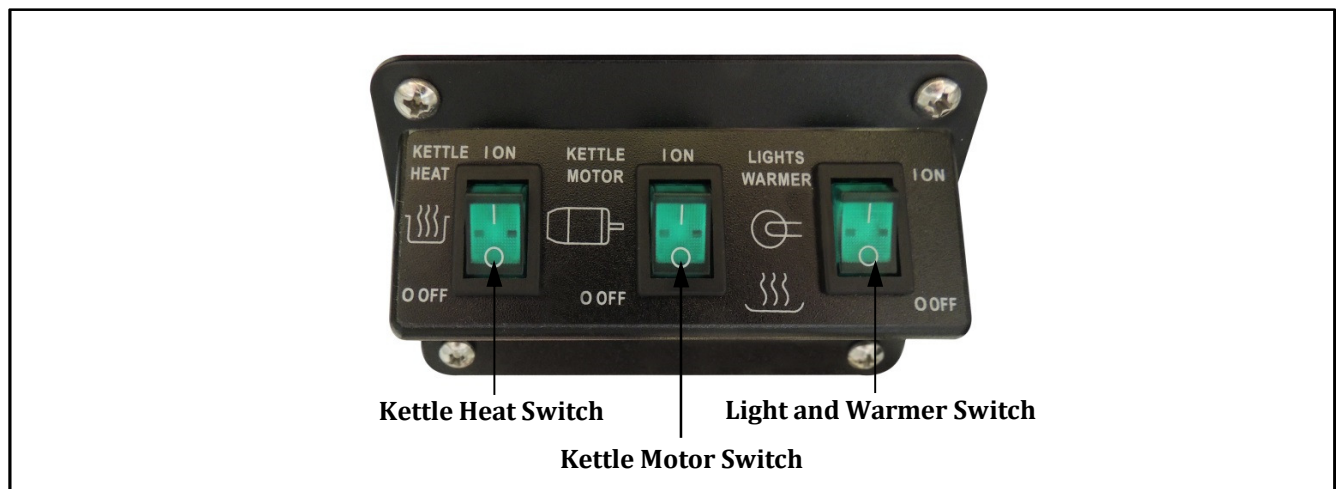



Popping Corn Instructions

This section describes instructions for popping Standard (salted) popcorn.

Amount of Popcorn and Oil

The popper is equipped with a corn, salt, and oil measure. We recommend flavored and colored coconut oil. Popcorn popped in coconut oil stays fresh longer and does not leave black deposits in the kettle like other oils. Use only top quality, fresh popcorn from reputable suppliers.

Kettle Size	Popcorn Charge	Oil Charge	Flavacol (Salt)
4 oz.	4 oz. (118 ml)	1 to 1.3 oz. (30 to 38 ml)	1 Teaspoon (5cc)

For best results use Mega-Pop® 4 oz. premeasured pouches (Item# 2834).

Popping Standard (Salted) Popcorn

1. Turn all switches ON.
2. To determine when kettle is ready to pop corn (about 4 minutes), test pop three kernels of corn in one ounce (30 ml) of popping oil. When kernels pop, kettle is ready.
3. Lift kettle lid and load Mega-Pop® premeasured popcorn and oil pouch, or pour in popcorn and Flavacol, then add oil in premeasured amount. Close lid.
4. When corn has finished popping, gently dump the popcorn.
5. On final kettle of corn, turn Kettle Heat Switch OFF just as lids are forced open by the popping corn. This procedure saves electricity, since kettle has plenty of heat, and helps eliminate smoke/odor from any oil residue that remains after popping has stopped.
6. When finished popping, turn KETTLE HEAT and KETTLE MOTOR switches OFF.

NEVER LEAVE THE HEAT ON WHEN YOU ARE NOT POPPING CORN!



Care and Cleaning

	⚠ DANGER
	Machine must be properly grounded to prevent electrical shock to personnel. DO NOT immerse in water. DO NOT clean appliance with a water jet. Always unplug the equipment before cleaning or servicing. 025_111616

	⚠ WARNING
	To avoid serious burns, DO NOT touch the kettle while it is hot! 028_082715

Good sanitation practice demands that all food preparation equipment be cleaned regularly (only use non-toxic, food grade cleaners). A clean looking, well-kept machine is one of the best ways of advertising your product.

Note: It is extremely important to follow all cleaning procedures, otherwise parts damage and equipment failure will result. The warranty does not cover parts that are damaged due to improper cleaning.

Daily Kettle Cleaning Instructions

CAUTION: A hot kettle will cause burns if you touch it with your hand. Allow kettle to cool at least 1 hour before attempting to clean. **DO NOT** use ice or water to cool down a hot kettle! Severe kettle damage will result!

1. When cool, wipe **outside** of kettle with a clean, soft cloth. **DO NOT** use oven cleaners or abrasive materials as they will damage the kettle.
2. Every night, mix Gold Medal's Heat'n Kleen solution (Item No. 2095), 2 tablespoons per gallon of water. It is not necessary to use the entire gallon at once; only use enough to fill the kettle 1/2 inch deep.
3. Turn kettle heat ON. When water starts to boil, turn kettle heat OFF.
4. Allow to cool at least 1 hour, then dump solution into a bucket and wipe inside of kettle with a clean cloth. Make sure all solution goes into the bucket; do not spill any in the interior of machine.

For an extra dirty kettle, the process may be repeated; or, after turning kettle heat OFF, allow solution to sit in kettle overnight. The next morning, dump solution into a bucket and wipe inside of kettle with a clean cloth.

5. With unit OFF and unplugged, wipe kettle lead cord with a clean SLIGHTLY damp cloth. **DO NOT get moisture into the kettle lead-in cord, severe damage will result.**



Daily Unit Cleaning Instructions

1. Turn machine OFF, unplug unit and allow it to cool before attempting to clean.
2. Clean all pans/accessories in order to sanitize them before each use.
3. Take a clean, SLIGHTLY damp cloth and wipe excess grease from glass and cabinet.
4. Wipe stainless steel parts with a clean cloth and cleaner designed for stainless steel, such as Gold Medal Watchdog Stainless Cleaner (Item No. 2088).

DO NOT use oven cleaners or abrasive materials as they will damage parts of machine.

5. Clean glass panels with glass cleaner. Gold Medal Watchdog Glass Cleaner (Item No. 2588) is recommended.

Ammonia cleaners will damage plastic doors/panels. Use only non-ammonia cleaners, such as Gold Medal Watchdog Glass Cleaner (Item No. 2588).



Troubleshooting

Issue	Possible Cause	Solution
Power to the Unit	A. Power to the Unit	A. Make sure the unit's power cord is plugged in.
Kettle Does Not Heat	A. Power to the Kettle B. Kettle Heat Switch C. Heating Element	A. Make sure kettle lead-in cord is plugged in and twisted to lock into the kettle receptacle. B. Have a qualified service person check the voltage to and from the Kettle Heat Switch; if switch is defective, replace it. C. Heating element in the kettle may be burned out. Check with a qualified service person for inspection/repair.
Long Popping Cycles (Longer than 4 minutes for Salt Popcorn)	A. Low Voltage B. Inadequate Supply Lines C. Inferior Corn	A. If the machine is operated on low voltage, this could cause the kettle not to reach the proper operating temperature. Check with a qualified electrician. B. Inadequately sized electrical supply lines or use of extension cord, in addition to being a fire hazard, would also prevent the kettle from reaching the proper operating temperature. Check with a qualified electrician. C. Inferior quality corn would result in longer popping cycles. Use only top quality hybrid popcorn from reputable suppliers. Even then, if you let your corn pick up moisture or dry out, your popping cycles will be slow.
Kettle Agitator Shaft not Rotating If the kettle agitator shaft is not rotating, DO NOT pop corn.	A. Kettle Motor Switch B. Kettle Agitator Shaft/Stir Blade not rotating. (Unit must be OFF, unplugged and cool prior to checking or adjusting the agitator assembly.)	A. Make sure the Kettle Motor Switch is ON. If the switch is ON, and the shaft is not rotating, the switch or motor may be faulty, contact qualified service personnel for inspection/repair. B. Kettles with a FLOATING Stir Rod – lift the agitator weight and check the clearance between the shaft and the kettle bottom; it should be a minimum of 1/32" (thickness of a dime). To make shaft adjustments, reference the Agitator Set Collar Adjustment section.



Agitator Set Collar Adjustment

The following instructions describe how to properly adjust set collars on an agitator assembly with a floating stir rod.

Steps to Adjust Set Collars

Step 1: Turn machine OFF, unplug unit, and allow it to cool completely before attempting to adjust the agitator height.

Step 2: Loosen the set screw in each set collar to be adjusted.

Step 3: With the kettle mounted in the popper, adjust the shaft so the Spur Gears are halfway engaged, and the Needle Bearing is at least halfway engaged in the gear block (reference image at right).

DO NOT set spur gears at full gear contact; it can cause binding as the kettle is dumped.

Step 4: Snug tighten only, the set screw in set collar above the crossbar to hold position. Then, lift the agitator weight and check the clearance between the shaft and the kettle bottom. If there is adequate clearance, fully tighten the set screw to secure set collar in place.

Step 5: Adjust clearance between the bottom of the crossbar and the lower set collar to 1/32" (thickness of a dime); then re-tighten set screw to secure in place (reference image).

Step 6: Adjust set collar for agitator weight to be between 3/16" to 1/4" above the agitator weight. Once adjusted, re-tighten set screw to secure in place.

Agitator shown for general image reference only (lids not shown for clarity).

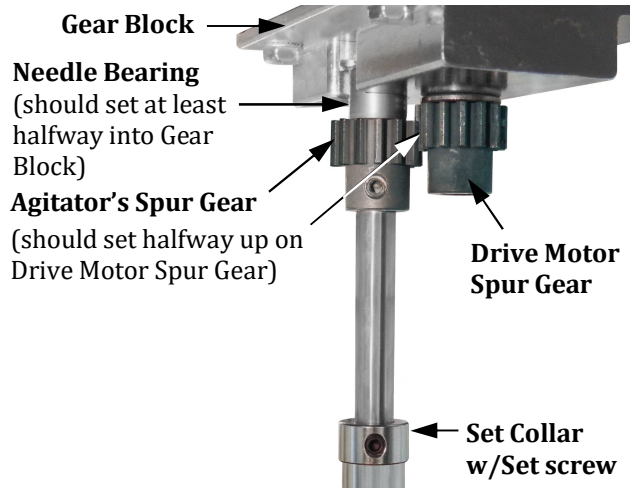

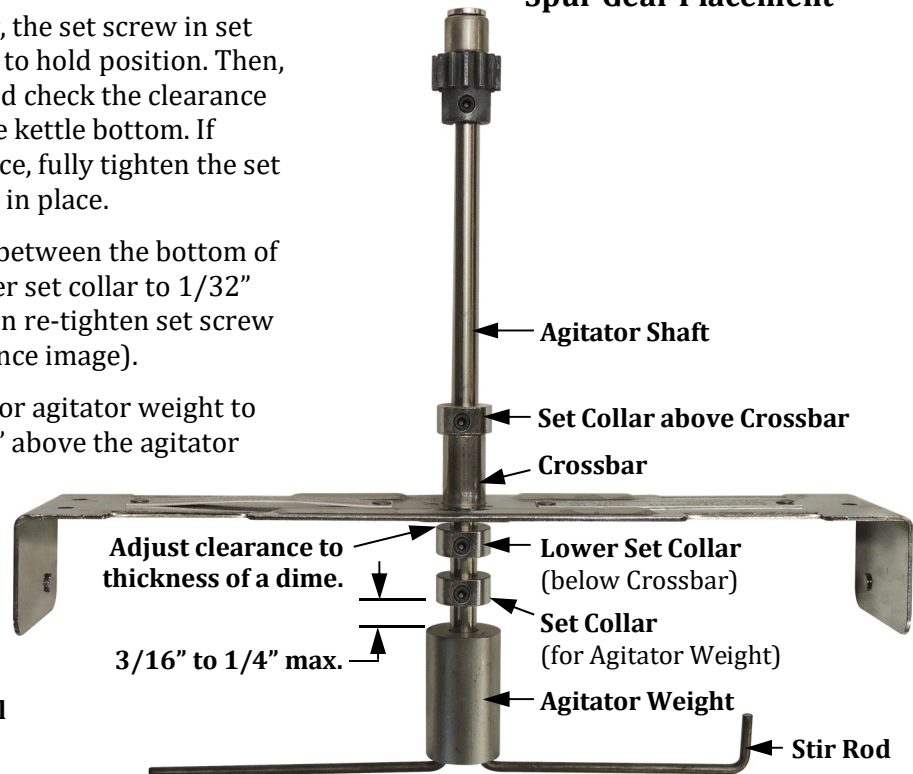

Spur Gear Placement







MAINTENANCE INSTRUCTIONS

	⚠ DANGER
	<p>Machine must be properly grounded to prevent electrical shock to personnel. Failure to do so could result in serious injury, or death. DO NOT immerse any part of this equipment in water. DO NOT use excessive water when cleaning. Keep cord and plug off the ground and away from moisture. Always unplug the equipment before cleaning or servicing. Make sure all machine switches are in the OFF position before plugging the equipment into the receptacle.</p> <p>008_051514</p>

	⚠ DANGER
	<p>Improper installation, adjustment, alteration, service, or maintenance can cause property damage, injury, or death. Any alterations to this equipment will void the warranty and may cause a dangerous condition. This appliance is not intended to be operated by means of an external timer or separate remote-control system. NEVER make alterations to this equipment. Read the Installation, Operating, and Maintenance Instructions thoroughly before installing, servicing, or operating this equipment.</p> <p>014_020416</p>

	⚠ WARNING
	<p>No user serviceable parts inside. Refer servicing to qualified service personnel.</p> <p>011_051514</p>

	⚠ CAUTION
	<p>THE FOLLOWING SECTIONS OF THIS MANUAL ARE INTENDED ONLY FOR QUALIFIED SERVICE PERSONNEL WHO ARE FAMILIAR WITH ELECTRICAL EQUIPMENT. THESE ARE NOT INTENDED FOR THE OPERATOR.</p> <p>027_010914</p>



ORDERING SPARE PARTS

1. Identify the needed part by checking it against the photos, illustrations, and/or parts list. (General images may be used in manual for reference only.)
2. Use only approved replacement parts when servicing this unit.
3. When ordering, please include part number, part name, and quantity needed.
4. Please include your model number, serial number, and date of manufacture (located on the machine nameplate/data plate) with your order.
5. Address all parts orders to Parts Department, Gold Medal Products Co., 10700 Medallion Drive, Cincinnati, Ohio 45241-4807

or place orders by phone or online:

Phone: (800) 543-0862
(513) 769-7676

Fax: (800) 542-1496
(513) 769-8500

E-mail: info@gmpopcorn.com
Web Page: gmpopcorn.com

Replacing Broken Glass

Broken glass panels can be easily replaced. Gold Medal Products Co. does not ship glass. It can be obtained from a local glass shop, always purchase tempered glass.

GLASS DIMENSIONS (Height x Width x Thickness)

Front and Side Glass: 18.25" x 14.51" x .127" (3 Pieces)

1. Turn machine OFF, unplug unit and allow it to cool before attempting to replace glass.
2. Remove all loose pieces of glass (kettle may be removed to change glass.)
3. Place a bungee (or large rubber band) around the unit to help hold corner posts in place, then remove dome.
4. Remove all rigid glass channels from around glass to be replaced, set channels aside for reuse.
5. Carefully remove the rest of the broken glass.
6. Apply decals (if desired) to new glass panel.
7. Slide rigid glass channels over exposed edges of new glass panel.
8. Slide new glass panel into machine.
9. Reattach dome, then remove bungee (reinstall kettle, if removed).



4 oz. Kettle Assembly (54000) – Agitator Assembly View

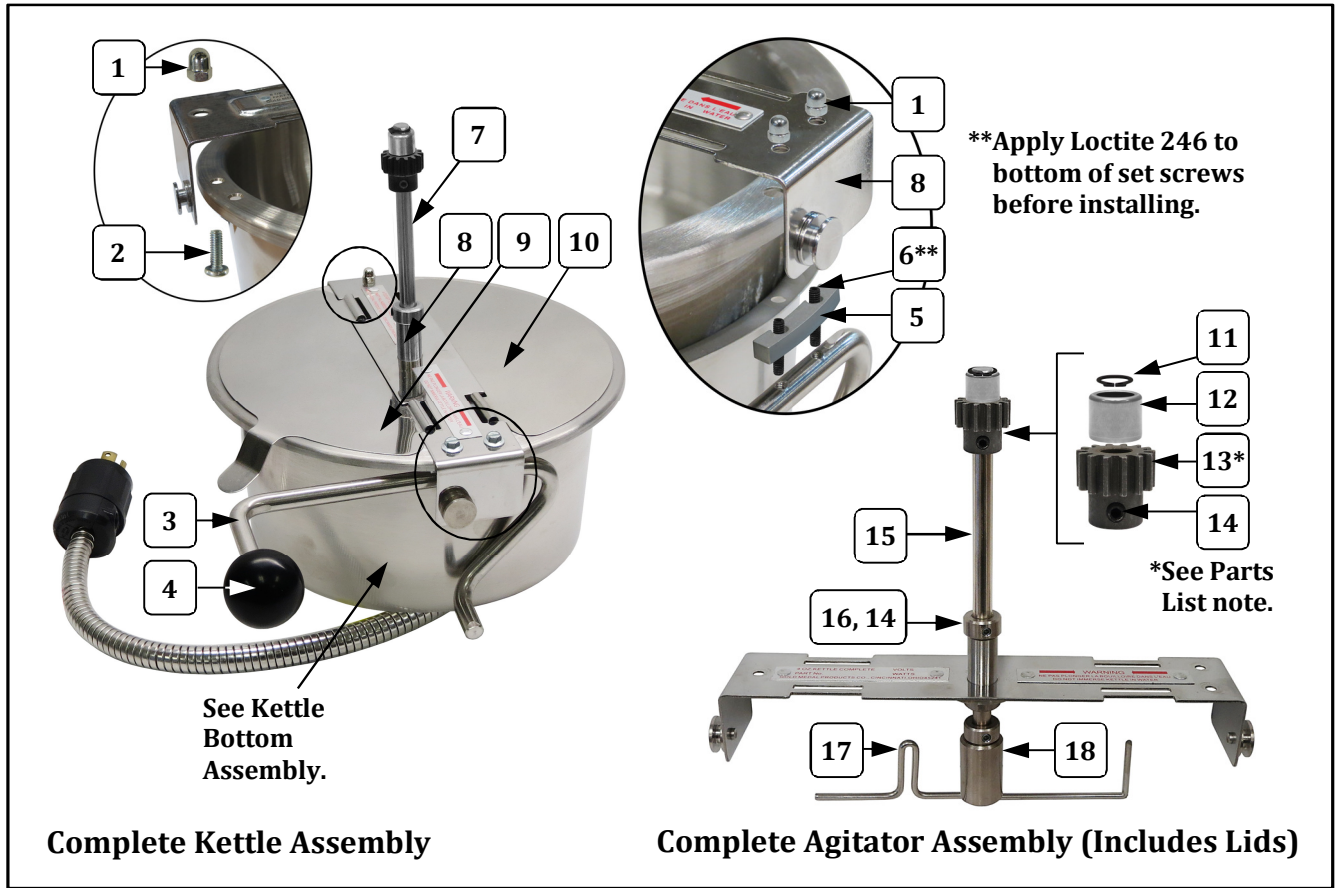

Complete Kettle Assembly

Complete Agitator Assembly (Includes Lids)

Item	Part Description	Part Number
		54000
1	ACORN NUT	47702
2	8-32 X 1/2 PHIL PAN M/S	47141
3	DUMP HANDLE RH	49314
4	DUMP HANDLE KNOB	47110
5	SPACER (for Dump Handle)	49362
6	8-32 X 1" SET SCREW	77933
7	AGITATOR & LID ASSY (Complete Assembly)	54407
8	KETTLE CROSSBAR ASSEMBLY	46779
9	FRONT LID W/FORMED LIFTER	55074
10	REAR KETTLE LID	55073
11	RETAINING RING	49701
12	NEEDLE BEARING	47106
13*	SPUR GEAR KIT (Includes 2 gears with set screws. Always replace Agitator Spur Gear and Kettle Drive Motor Gear as a set.)	47059K
14	SET SCREW #10-32 X 3/16	41742
15	4 OZ KETTLE AGITATOR SHAFT	54007
16	SET COLLAR 5/16 ID 5/8 OD	46649
17	4 OZ STIR ROD	54030
18	AGITATOR WEIGHT	49013



4 oz. Kettle Assembly (54000) – Kettle Bottom Assembly

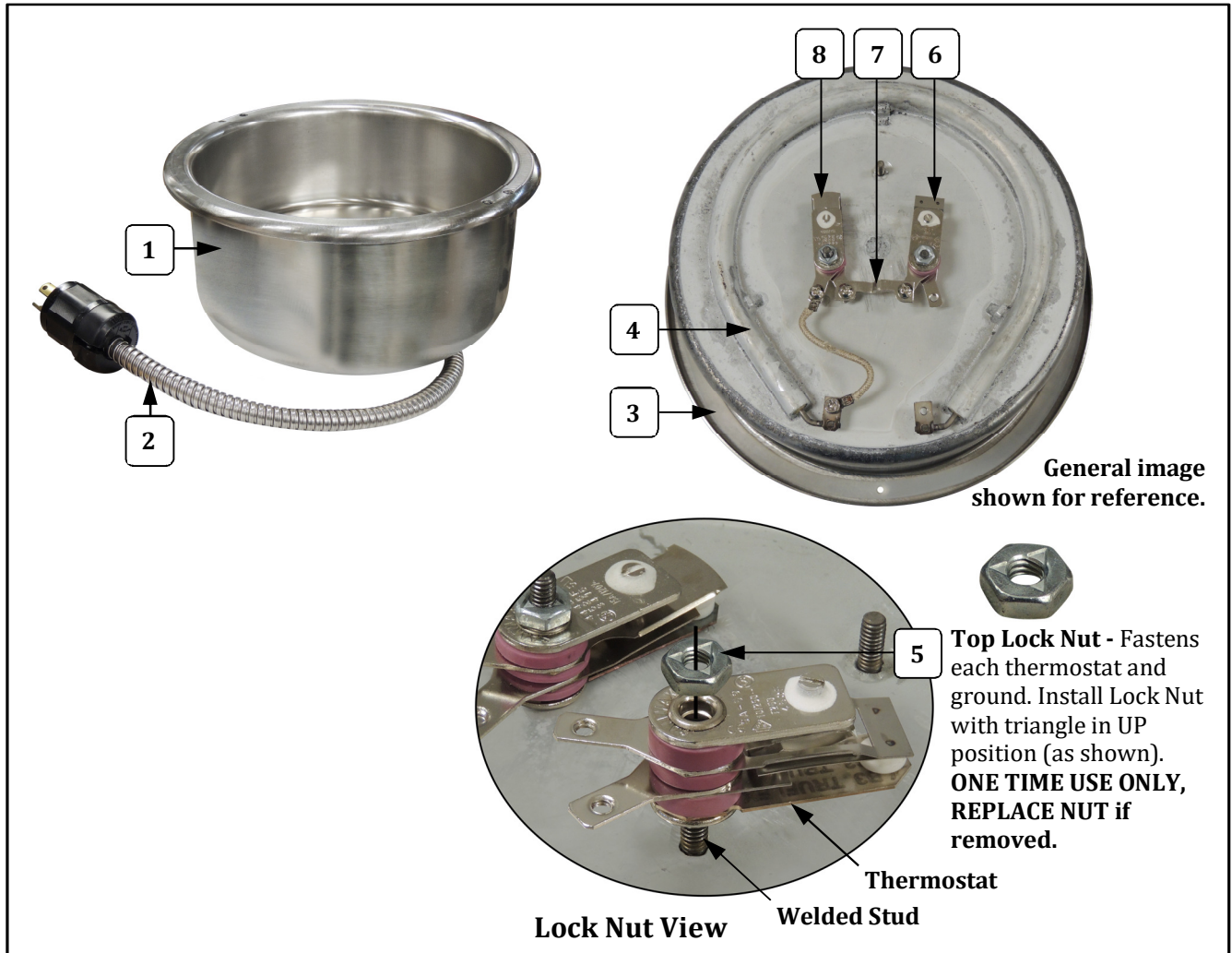

Item	Part Description	Part Number
		54000
1	4 OZ. KETTLE SHELL	54004
2	4 OZ. KETTLE LEAD ASSEMBLY	54028
3	4 OZ. KETTLE GASKET	54003
4	4 OZ. KETTLE/HEAT ELEMENT	54027
5	8-32 TOP LOCK NUT (always replace if removed)	67943
6	450°F THERMOSTAT (includes two 6-32 screws)	76089
7	THERMOSTAT SHUNT BAR	47193
8	525°F THERMOSTAT (includes two 6-32 screws)	76702



Cabinet Exterior – Front View

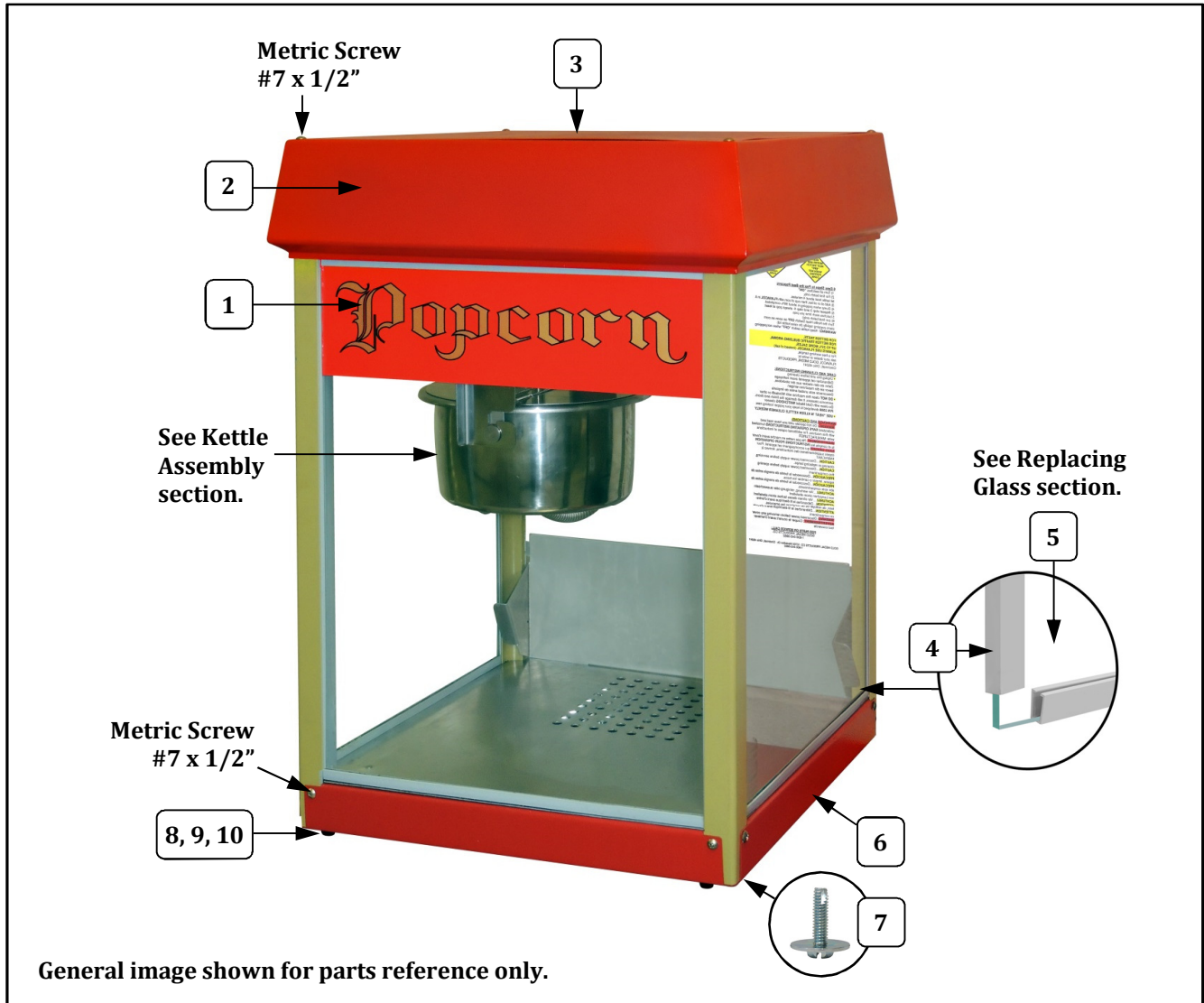

Item	Part Description	Part Number	
		2404	2404MD
1	DECAL POPCORN FRONT GLASS	56001	56001MD
2	DOME TOP WELDED ASSEMBLY	55089	55089BK
3	DOME COVER	55101	55101BK
4	GLASS CHAN 18.226 (used for top and bottom edges of glass panels – cut as needed)	55079	55079
5	GLASS 4 OZ POPPER (3 panels used)	50022	50022
6	BASE PAN	55063	55063BK
7	8-32 X 5/8 TYPE 23 HX HD (fastens base pan)	49052	49052
8	RUBBER BUMPER/FOOT	87247	87247
9	#8 INTERNAL TOOTH WASHER	12132	12132
10	#8-32 STAINLESS HEX NUT (fastens foot)	89129	89129



Cabinet Exterior – Rear View

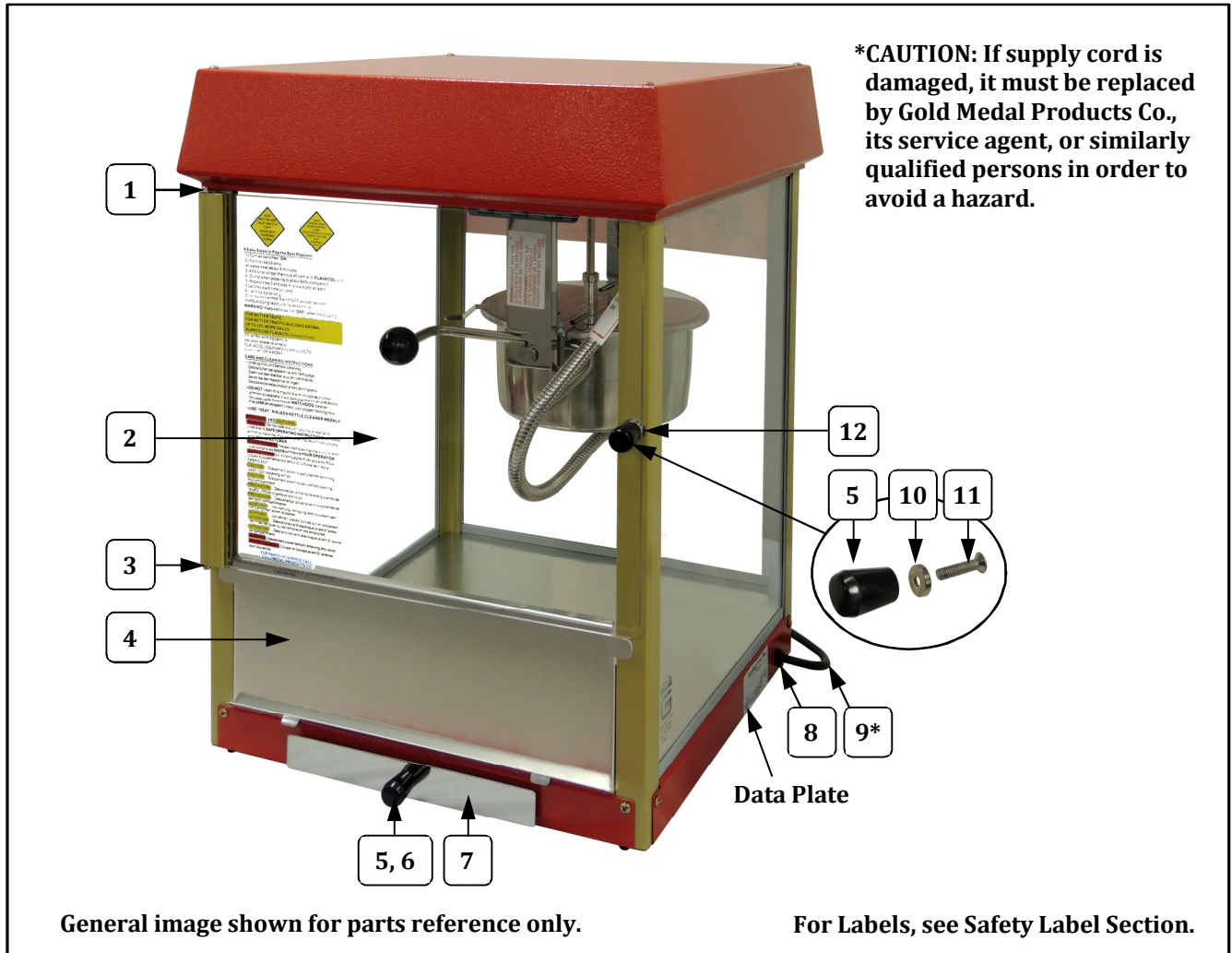

Item	Part Description	Part Number
		2404, 2404MD
1	TOP HINGE DOOR PIVOT BRACKET	55060
2	DOOR ASSEMBLY (includes door, hinge extrusion, and pins)	56011
3	BOTTOM HINGE DOOR PIVOT BRACKET	55061
4	DROP PANEL 4 OZ POPPER	55065
5	KNOB	47120
6	8-32 X 3/8 PH PAN W/SEMS (screw for knob)	42227
7	OLD MAID PAN	49100
8	SR-6P3-4 STRAIN RELIEF	76026
9*	LEAD-IN CORD 15 AMP PLUG	22038
10	MAGNET	50013
11	8-32X1/2 FL HD PH MS (screw for knob)	20066
12	LATCH CATCH	55104



Cabinet Interior – Hanger Assembly/Controls View

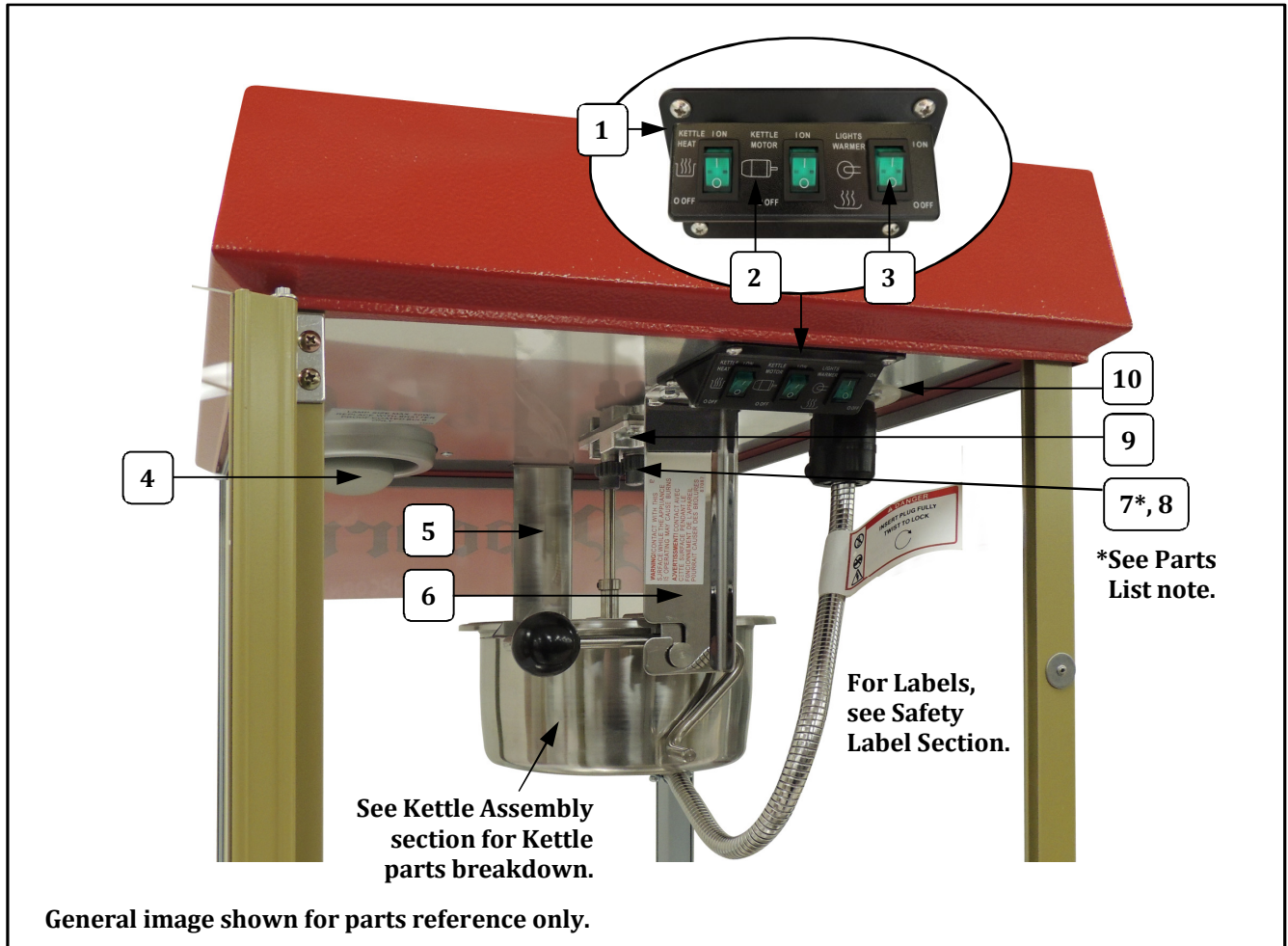

Item	Part Description	Part Number
		2404, 2404MD
1	SWITCH MOUNT	55076
2	SWITCH MOUNT DECAL	44070
3	DPST ROCKER SWITCH	42532
4	50 W FLOOD LIGHT COATED	42947
5	HANGER ARM REAR 4 OZ POPPER	55071
6	HANGER ARM FT 4 OZ POPPER	55070
7*	SPUR GEAR KIT (Includes 2 gears with set screws. Always replace Agitator Spur Gear and Kettle Drive Motor Gear as a set.)	47059K
8	10-32" X 3/16" SET SCREW	41742
9	GEAR BLK 4OZ ALUM DIE CST	55098A
10	L5-15R 15A RECEPTACLE	49330



Cabinet Interior – Corn Pan/Element View

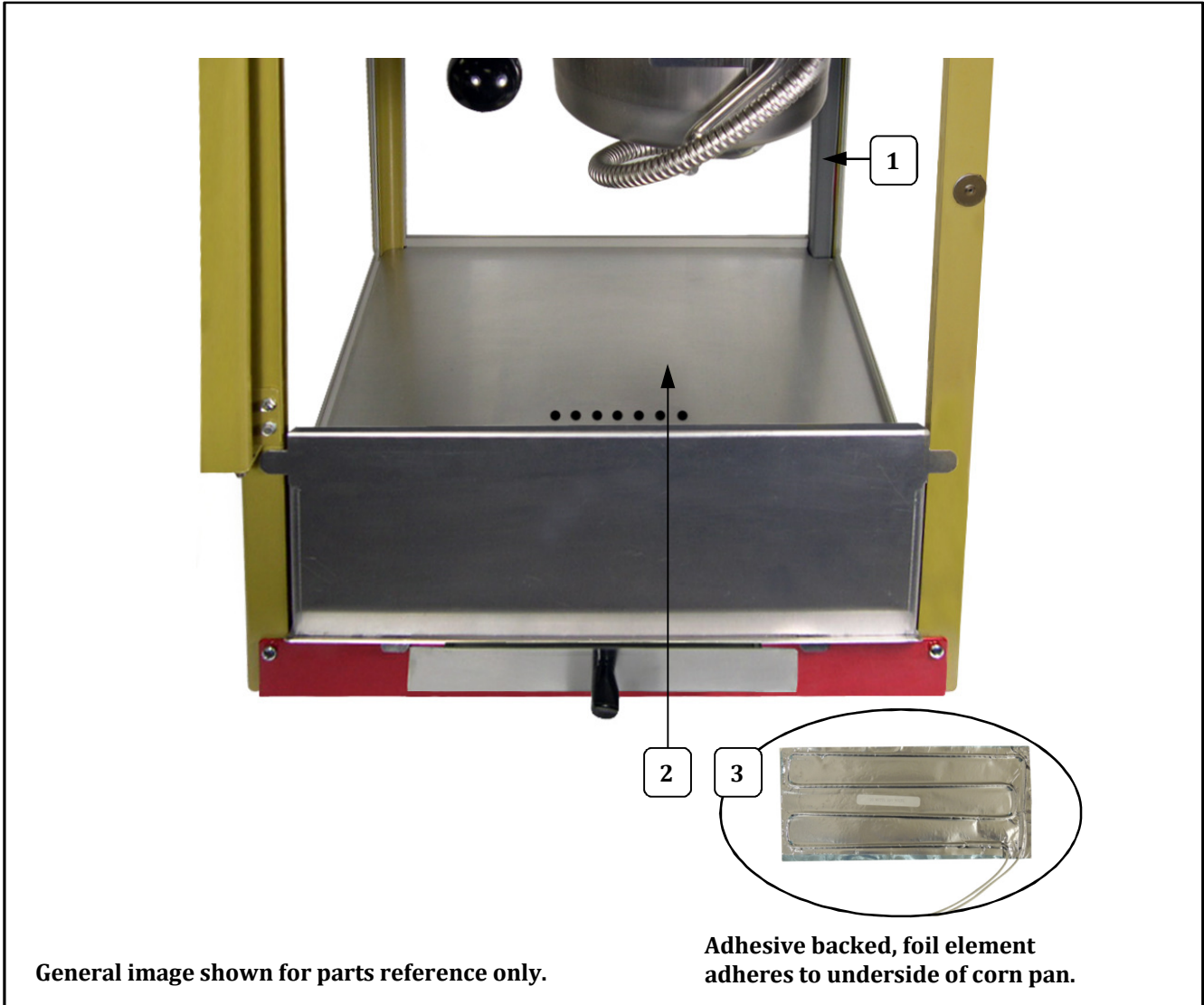

Item	Part Description	Part Number
		2404, 2404MD
1	WIRE ROUTE COVER (runs the entire length of the corner post)	55077
2	CORN PAN 4 OZ POPPER	55069
3	20 WATT 120V FOIL HEATER	40557



Dome Interior – Electrical Components

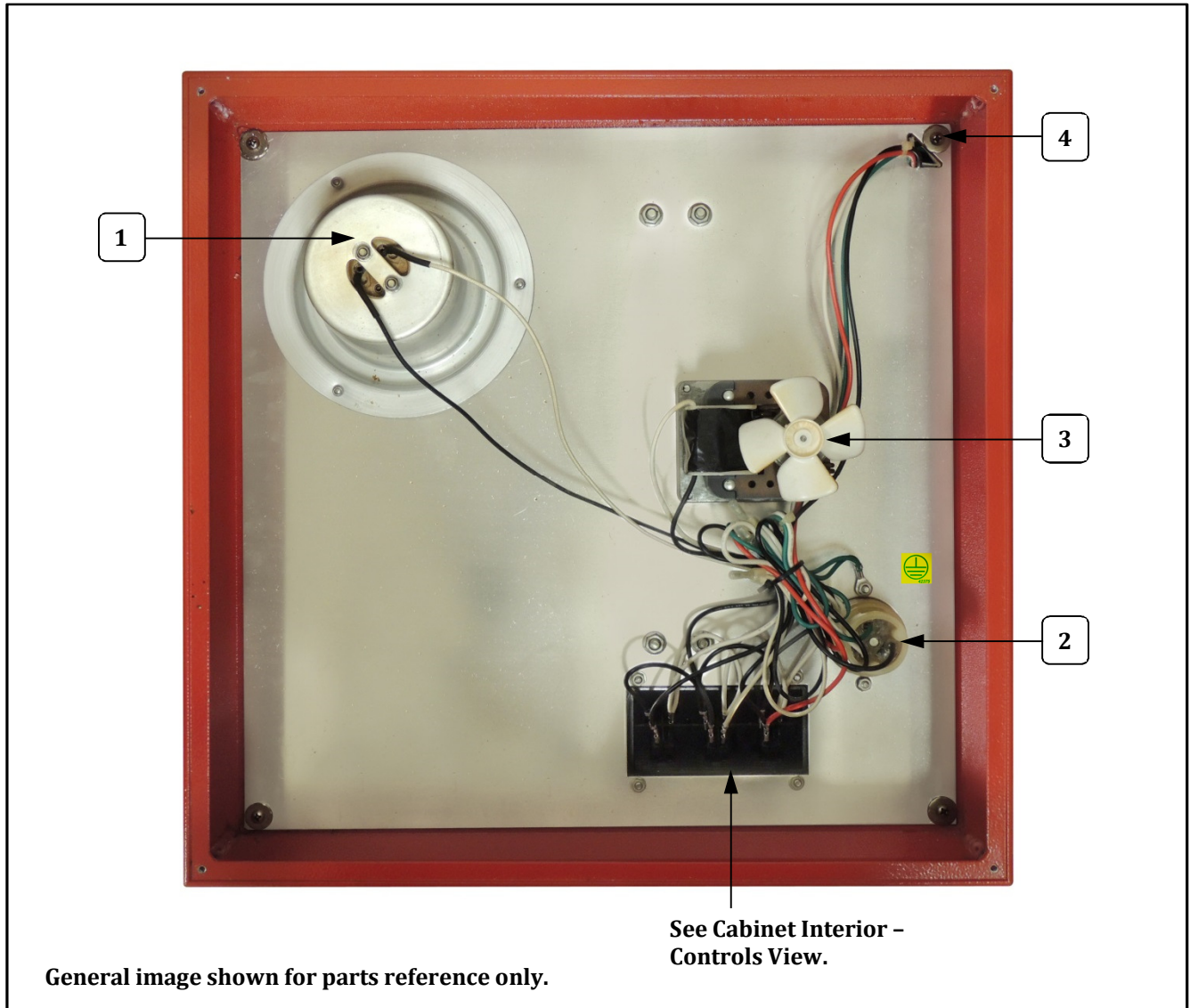

Item	Part Description	Part Number
		2404, 2404MD
1	LITE CONE AND SOCKET ASSEMBLY	56070
2	L5-15R 15A RECEPTACLE	49330
3	120V KETTLE DRIVE MOTOR	49045
4	8-32 X 5/8 TYPE 23 HX HD	49052



Safety Labels

Unit Labels

- 1: UNIVERSAL POPPER DECAL (41019)
- 2: LABEL - MAX WATT COATED (44948)
- 3: MAIN GROUND LABEL (42375)
- 4: WARNING, SURFACE CONTACT (87087)

Power Cord Label

- 5: CONDUIT WARNING LABEL (82840)
- 6: WARNING LABEL CORD (68720)

Item	Part Description	Part Number
		All Models
1	UNIVERSAL POPPER DECAL	41019
2	LABEL - MAX WATT COATED	44948
3	MAIN GROUND LABEL	42375
4	WARNING, SURFACE CONTACT	87087
5	CONDUIT WARNING LABEL	82840
6	WARNING LABEL CORD	68720

Accessories

1: SCOOP (2071NM)

2: MEASURE 6.5CC (47678)

3: OIL SCOOP 38 CC 2404 (44446)

4: 4/6 OZ CORN MEAS CUP (44445)

Item	Part Description	Part Number
		All Models
1	SCOOP	2071NM
2	MEASURE 6.5CC	47678
3	OIL SCOOP 38 CC 2404	44446
4	4/6 OZ CORN MEAS CUP	44445



Wiring Diagram

Model No. 2404 and 2404MD

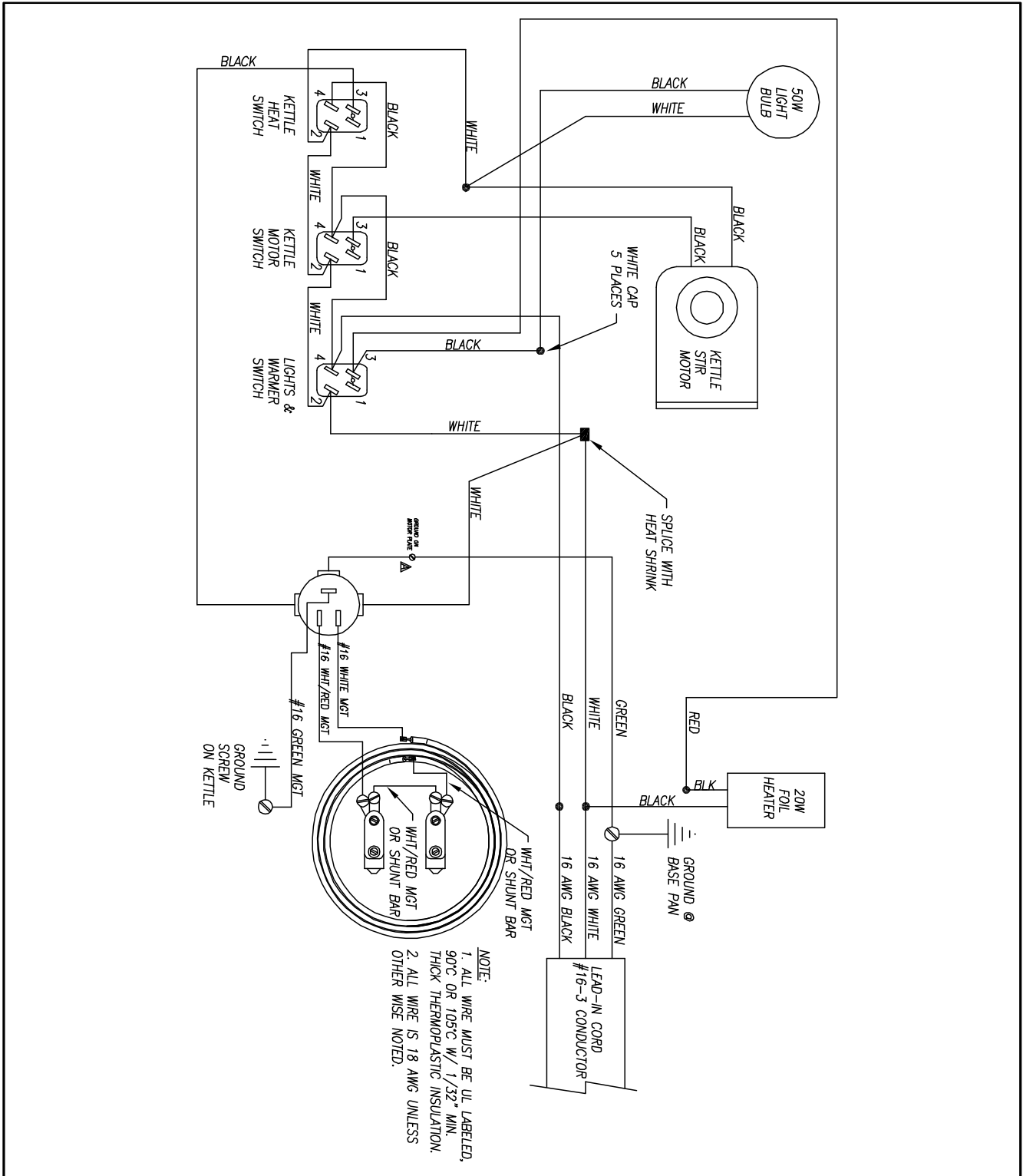



WARRANTY

Gold Medal Products Co. warrants to the original purchaser each item of its manufacture to be free of defects in workmanship and material under normal use and service. Gold Medal Products Co.'s obligation under this warranty is limited solely to repairing or replacing parts, f.o.b. Cincinnati, Ohio, which in its judgment are defective in workmanship or material and which are returned, freight prepaid, to its Cincinnati, Ohio factory or other designated point. Except for "Perishable Parts" on specific machines, the above warranty applies for a period of two (2) years from the date of original sale to the original purchaser of equipment when recommended operating instructions and maintenance procedures have been followed. These are packed with the machine. Parts warranty is two (2) years, labor is six (6) months.

THIS WARRANTY IS IN LIEU OF ALL OTHER WARRANTIES EXPRESSED OR IMPLIED, AND OF ALL OTHER OBLIGATIONS OR LIABILITIES ON OUR PART, INCLUDING THE IMPLIED WARRANTY OF MERCHANTABILITY. THERE ARE NO WARRANTIES WHICH EXTEND BEYOND THE DESCRIPTION ON THE FACE HEREOF. In no event shall Gold Medal Products Co. be liable for special, incidental or consequential damages. No claim under this warranty will be honored if the equipment covered has been misused, neglected, damaged in transit, or has been tampered with or changed in any way. No claim under this warranty shall be honored in the event that components in the unit at the time of the claim were not supplied or approved by Gold Medal Products Co. This warranty is effective only when electrical items have been properly attached to city utility lines only at proper voltages. This warranty is not transferable without the written consent of Gold Medal Products Co.

The term "Original Purchaser" as used in this warranty shall be deemed to mean that person, firm, association, or corporation who was billed by the GOLD MEDAL PRODUCTS CO., or their authorized distributor for the equipment.

THIS WARRANTY HAS NO EFFECT AND IS VOID UNLESS THE ORIGINAL PURCHASER FIRST CALLS GOLD MEDAL PRODUCTS CO. AT 1-800-543-0862 TO DISCUSS WITH OUR SERVICE REPRESENTATIVE THE EQUIPMENT PROBLEM, AND, IF NECESSARY, FOR INSTRUCTIONS CONCERNING THE REPAIR OR REPLACEMENT OF PARTS.

NOTE: This equipment is manufactured and sold for commercial use only.



GOLD MEDAL PRODUCTS CO.

10700 Medallion Drive, Cincinnati, Ohio 45241-4807 USA

gmpopcorn.com

Phone: (800) 543-0862 Fax: (800) 542-1496
(513) 769-7676 (513) 769-8500

© 2018 – The text, descriptions, graphics, layout, and other material in this publication are the exclusive property of Gold Medal Products Co. and shall not be used, copied, reproduced, or published in any fashion, including website display, without its express written consent.